



OWN YOUR
HARVEST™

TRP STACK ROSIN PRESS USER GUIDE

V1.0

INTRODUCTION	3
DISCLAIMER	3
WARNING LABELS	4
SERVICE AND REPAIRS	4
GENERAL SAFETY PRECAUTIONS	6
COMPONENTS	7
GET TO KNOW YOUR TRP STACK ROSIN PRESS	7
GETTING STARTED	8
BEFORE OPERATION	8
SAFETY CHECK	8
CONNECT POWER CORD	8
ATTACH HYDRAULIC PUMP UNIT	8
STARTING THE ROSIN PRESS	9
STOPPING THE ROSIN PRESS	9
PID SETTINGS	9
PID STANDARD OPERATIONAL PARAMETERS	10
OPERATION	12
SET TEMPERATURE	12
PRESSING ROSIN	12
TROUBLESHOOTING THE PID	12
RESETTING PID PARAMETERS	13
UNLOCK GENERAL SETTINGS PID MENU	13
UNLOCK ADVANCED SETTINGS PID MENU	13
RESET THE GENERAL SETTINGS PID PARAMETERS TO DEFAULT VALUES	14
RELOCK GENERAL SETTINGS PID MENU 1	14
RELOCK GENERAL SETTINGS PID MENU 2	14
SETTING MAXIMUM PLATEN TEMPERATURE	15
WARRANTY	16

INTRODUCTION

Congratulations on your selection of the Trinator TRP Stack Rosin Press! We want to help you get the best results from your new rosin press and operate it safely. This manual contains information on how to do that; please read it carefully before you set up and use your rosin press.

We suggest you read the LIMITED WARRANTY to understand coverage and your responsibilities of ownership fully. Keep this user guide handy, so you can refer to it at any time. This user guide is considered a permanent part of the rosin press and should remain with the rosin press if resold. The information and specifications included in this publication are those that were in effect at the time of approval for printing. Eteros Technologies, (Eteros) reserves the right, however, to discontinue or change specifications or design at any time without notice and without incurring any obligation whatsoever. No part of this publication may be reproduced without written permission.

DISCLAIMER

Eteros Technologies recognizes that the TRP Stack Rosin Press is purpose-built for processing cannabis by licensed producers. Please check all municipal, provincial/state, and federal laws and regulations before using the TRP Stack Rosin Press. Eteros Technologies does not promote or condone the use of processing equipment in any way that may be deemed illegal.



Eteros Technologies recognizes that our equipment can be used for processing herbs, hops, flowers, and many other products. It is not the responsibility of Eteros Technologies to confirm alternative applications for our equipment.

WARNING LABELS

Your safety and the safety of others are very important. We have provided important safety messages in this manual and on the Trinator TRP Stack. This information alerts you to potential hazards that could hurt you or others. Please read these messages carefully. Of course, it is not practical or possible to warn you about all the hazards associated with operating or maintaining a rosin press. You must use your own good judgment.

You will find important safety information in a variety of forms:

- **Safety Labels** - located on the rosin press.
- **Instructions** - how to use this rosin press correctly and safely.
- **Safety Messages** - preceded by a safety alert; a symbol and one of three signal words: DANGER, WARNING, or CAUTION.

	<p>DANGER:</p> <p>Indicates a hazardous situation that, if not avoided, will result in serious injury and/or death. This signal word is to be limited to the most extreme situations; typically for machine components that, for functional purposes, cannot be guarded.</p>
	<p>WARNING:</p> <p>Indicates a potentially hazardous situation that, if not avoided, could result in serious injury and/or death. It includes hazards that are exposed when guards are removed. It may also be used to alert against unsafe practices.</p>
	<p>CAUTION:</p> <p>Indicates a potentially hazardous situation that, if not avoided, may result in minor or moderate injury. It may also be used to alert against unsafe practices.</p>

Damage Prevention Messages - You will also see other important messages that are preceded by the word NOTICE. This word means:

NOTICE Your rosin press or other property can be damaged if you don't follow instructions.

SERVICE AND REPAIRS

Repairs may only be carried out by Eteros Technologies or a designated authorized agent (service technician).

Should the need arise, please notify us:

Eteros Technologies
6175 South Sandhill Road, Unit 600,
Las Vegas, NV 89120

www.eteros.com
www.thetriminator.com
service@thetriminator.com
(530) 265 4277

Improper interfacing, improper repair, or an unauthorized modification could result in void warranty claims.

GENERAL SAFETY PRECAUTIONS

IMPORTANT SAFETY INFORMATION

Trinator rosin presses are designed to extract essential elements from plants containing resin glands utilizing heat and pressure and from a variety of herbal materials. Other uses could result in injury to the operator or damage to the rosin press and or other property. Injuries and property damage arising from the use of the Trinator rosin press can be prevented by following all instructions in this manual and on the rosin press. The most common hazards are discussed below, along with the best way to protect yourself and others. Your safety is your responsibility.

OPERATE ON FLAT SURFACE

To avoid overturning, only operate the rosin press on flat, hard, durable surfaces. Preferably at table height or higher for best access and operator visibility. The press is heavy and must be positioned on a flat surface to prevent any accidental upset or tip-over.

AVOID CONTACT WITH HEAT PLATENS

Heat platens can operate at temperatures up to 225°F (107°C). Prolonged contact can cause serious burns. Note red indicator light on power button indicating power ON and platens hot.

TURN ELECTRIC POWER OFF AND UNPLUG WHEN NOT OPERATING THE ROSIN PRESS

If you need to leave the rosin press for any reason, always turn the electric power off.

MANUAL HYDRAULIC PUMP

Do not place fingers or other body parts in area between heat platens when hand pumping hydraulic pump. Pinching or crushing injuries could result.

AIR OR ELECTRIC HYDRAULIC POWER OPTIONS

Do not place fingers or other body parts in area between heat platens. Keep BOTH hands on power unit controls at all times when hydraulically closing press platens.

All rosin press loading and closing functions are to be activated by a single-person operator ONLY.

OPERATOR RESPONSIBILITY

Know how to stop and reverse press action immediately in case of emergency. Understand the use of all rosin press controls. Never permit anyone to operate the rosin press without proper instruction. Do not let children operate the rosin press.

COMPONENTS

GET TO KNOW YOUR TRP STACK ROSIN PRESS

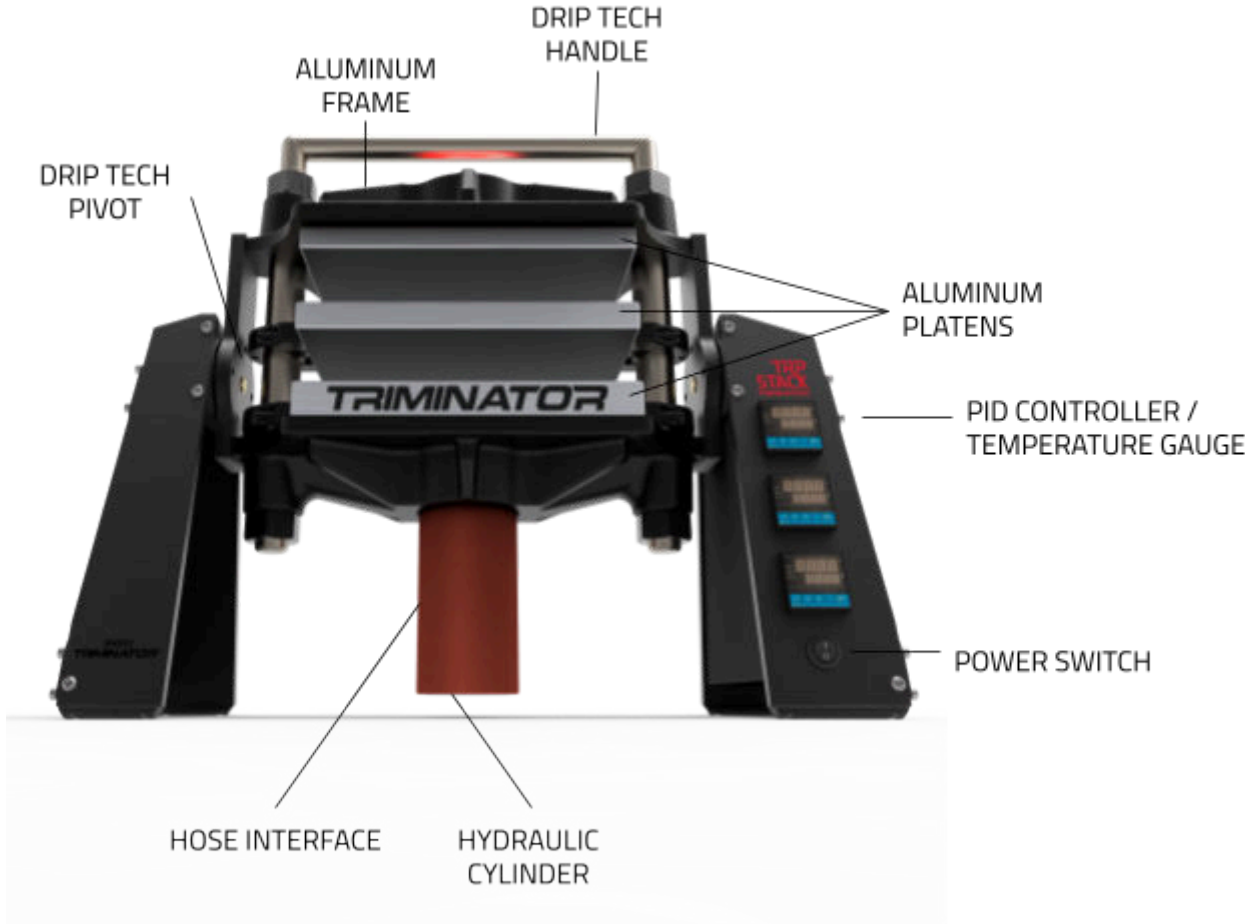

GETTING STARTED

BEFORE OPERATION

Read and understand this manual. Know what the controls do and how to operate them. Familiarize yourself with the rosin press and its operation before you begin using it. **Know how to quickly shut off the machine in case of an emergency.**

SAFETY CHECK

For your safety, and to maximize the service life of your equipment, it is very important to take a few moments each time before you operate the press to check its condition. Be sure to take care of any problem you find before you operate the rosin press.

Improperly maintaining this rosin press, or failing to correct a problem before operation, could cause a malfunction which could cause you to be seriously injured.

Always perform a pre-operation inspection before each operation, and correct any problem.

Before beginning your pre-operation check, be sure the rosin press is on a level surface, the power switch is in the OFF position, and power cord is unplugged.

CHECK THE GENERAL CONDITION OF THE ROSIN PRESS

- Check each control for proper operation.
- Check parts for wear. Replace if necessary.
- Check that all nuts, bolts, and clamps are tightened appropriately.

CONNECT POWER CORD

Connect the rosin press power cord to a 20A 120V AC circuit. Optional air or electric power units may be plugged into the same outlet. Do not connect and disconnect the power cord with wet hands. Do not operate in the rain.

NOTICE The Rosin Press machine alone draws approximately 10 amps. With optional electric power unit, total current draw will be approximately 20 amps.

ATTACH HYDRAULIC PUMP UNIT

Connect hose from manual, air, or electric hydraulic pump to Rosin Press cylinder. Engage hose fitting by pushing into mating cylinder and turning locking ring to secure.

NOTICE Ensure hose tip is fully seated with no threads showing. If it is not fully seated, fluid will not flow to and from the pump, and platens will not move up and down properly.

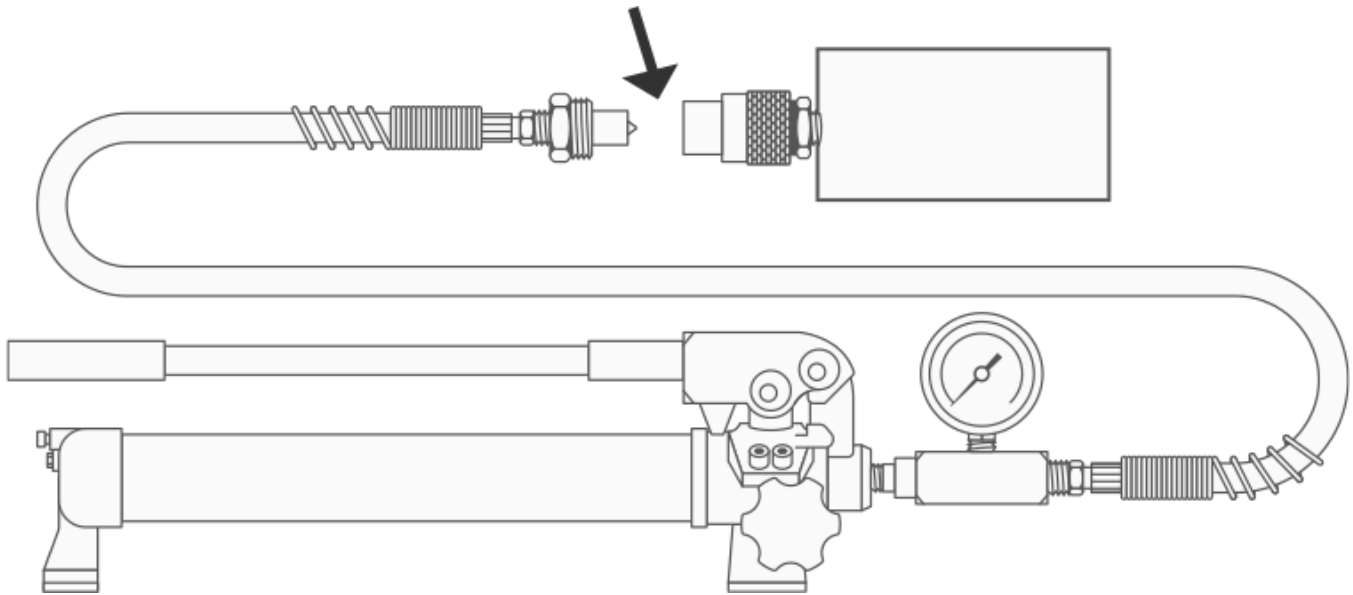

STARTING THE ROSIN PRESS

Flip the power switch to the ON position. Heat platens will take up to 15 minutes to heat and stabilize at desired temperature.

STOPPING THE ROSIN PRESS

Flip the power switch to the OFF position.

DISCONNECT POWER CORDS

Unplug Rosin Press cord from power outlet. Unplug optional air or electric hydraulic power unit from AC outlet.

COOL DOWN

Allow sufficient time in power off mode for Rosin Press to cool before attempting to move machine.

NOTICE Be sure to hold the plug when disconnecting the power cord from the electrical outlet. Do not disconnect by pulling on the power cord.

PID SETTINGS



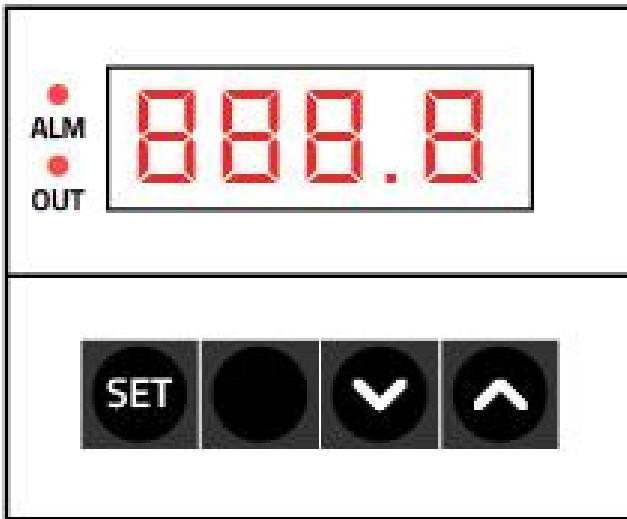

Your press has a PID controller on it, it has a temperature sensor and two heating cartridges per platen. These elements communicate with each other in a permanent closed loop controlled by a microcomputer.

Your PIDs come preset with Standard Operational Parameters however some users may want to adjust or fine-tune the PIDs further.

PID INTERFACE



CONTROLS

SET TEMPERATURE	PRESS AND HOLD  3 SECONDS
ACCEPT VALUE / ADVANCE TO NEXT MENU ITEM	PRESS 
ACCESS GENERAL SETTINGS	PRESS AND HOLD   3 SECONDS
ACCESS ADVANCED SETTINGS	PRESS AND HOLD  3 SECONDS
RETURN TO HOME	PRESS SET OR ALLOW 8 SECONDS TO TIME OUT

PID STANDARD OPERATIONAL PARAMETERS

The following settings have been optimized by Trimator engineers to provide the best platen performance. Refer to the PID Manufacturing Settings graph. Follow these settings exactly.

PRESS AND HOLD **SET** + **▲** 3 SEC

GENERAL SETTINGS MENU

LOCK

Loc	1
-----	---

1= locked
0= Unlocked

PRESS **SET** TO ADVANCE

SENSOR

Sn	4
----	---

DECIMAL POINT **SET**

dP	1
----	---

LOW TEMP LIMIT **SET**

dIL	0
-----	---

HIGH TEMP LIMIT **SET**

dIH	275.0
-----	-------

TEMP UNIT **SET**

CF	F*
----	----

FILTER MODULUS **SET**

PF	20
----	----

PRESS AND HOLD **SET** 3 SEC

ADVANCED SETTINGS MENU

ALARM 1

AL1	275
-----	-----

PRESS **SET** TO ADVANCE

OFFSET

SC	-5.0
----	------

P PARAMETER **SET**

P	15
---	----

I PARAMETER **SET**

I	240
---	-----

D PARAMETER **SET**

d	30
---	----

CONTROL FREQUENCY **SET**

t	10
---	----

HYSTERESIS FOR BANG-BANG **SET**

HY	1
----	---

AUTO TUNING **SET**

At	OFF
----	-----

LOCK **SET**

Loc	1
-----	---

NOTICE Make sure your Temp Unit is set to Fahrenheit. Setting Fahrenheit temps in Celsius can result in melting components of the machine.

OPERATION

Program optimal press platen temperature into temperature control (PID) units. Typically press operation will be between 195° to 220°F.

SET TEMPERATURE

1. Press and hold **UP ARROW** button for 3 seconds.
2. Press **UP** or **DOWN ARROW** until desired temp is shown.
3. Press **SET** button.

PRESSING ROSIN

1. With the power on, **wait at least 15 minutes after Rosin Press starts for press platens to reach desired and stable temperature.** Note that some slight fluctuation is normal.
2. Insert pre-filled filter bag packet(s) and PTFE catchment paper between press platens. To optimize press performance, position bags close to center of press platen surface. Multiple small bags may be used.
3. Close press platens by activating hydraulic pump, either by hand unit or with power pump options. Pressure gauge on pump will read approximately 500 psi. Wait until liquid can be seen forming along packet edges, then slowly increase pump pressure to 7000 psi. Combination of heat and intense pressure will push out all liquid rosin material from filter bag packets.
4. Maximum recommended pressure as viewed on pump gauge is 7000 psi. Approximately 20 Tons at press platens.
5. When all rosin has been extracted, release pump pressure. Platens will return to open position. Remove spent filter bag packet and catchment paper, reload with fresh material, and repeat press operation.
6. When filter bag packet and catchment paper have cooled sufficiently, dried rosin material may be removed.

TROUBLESHOOTING THE PID

If you find a platen or platens are not functioning properly, you may wish to reset the PID. Some of the most common issues people may have are below.

PROBLEM	POSSIBLE CAUSE	SOLUTION
PRESS DOESN'T REACH THE PRESET TEMPERATURE	PID parameters set up incorrectly.	Verify Standard Operational Parameters are set to the suggested values. If your settings don't match the suggested values, follow steps to Reset Parameters .
TEMPERATURE GUN SHOWS A DIFFERENT TEMPERATURE	Reading temperatures in reflective surfaces or at an angle.	Use a contact thermometer with a lubricant between the tip of the reader and the specific surface area for which you want to read the temperature. For temperature gun use; paint a black spot on the surface of the platen with a permanent marker. Take the reading as close as possible to that spot, perpendicular to the surface.

RESETTING PID PARAMETERS

UNLOCK GENERAL SETTINGS PID MENU

1. Press and hold **SET** button and **UP** arrow for 3 seconds.
2. Press **SET** button to advance through settings until you get to the screen Loc.
3. Press **UP** to increase number or **DOWN** arrow to decrease number until you get to the number 0, then press **SET** button again until you get to the main screen or allow the screen to timeout to return to the main screen.

Now the PID is unlocked and the parameters can be reset.

UNLOCK ADVANCED SETTINGS PID MENU

1. Press and hold **SET** button for 3 seconds.
2. Press **SET** button to advance through settings until you get to the screen Loc.

3. Press **UP** to increase number or **DOWN** arrow to decrease number until you get to the number 0, then press **SET** button again until you get to the main screen or allow the screen to timeout to return to the main screen.

NOTE: Unlocking either General or Advanced settings will unlock the other.

RESET THE GENERAL SETTINGS PID PARAMETERS TO DEFAULT VALUES

The following settings have been optimized by Triminators engineers to provide the best platen performance. Refer to the PID Manufacturing Settings graph. Follow these settings exactly.

1. Press and hold **SET** button and **UP** arrow for 3 seconds.
2. Push **SET** button to advance through settings
3. Push **UP** to increase number or **DOWN** arrow to decrease number until you get to the desired value. Enter the setting based on the numbers provided in the PID Manufacturing Settings graph.
4. Push **SET** button again and continue setting all the values.

For P, I, and D, the settings are dependent on top or bottom platen. Use chart numbers shown in the **PID Standard Operational Parameters** graphic to set the platens.

Once all values have been set, push SET button again until you get to the main screen or allow the screen to timeout to return to the main screen.

Once you have your PID parameters set. Lock your PID Menu to prevent any changes.

RELOCK GENERAL SETTINGS PID MENU 1

1. Push **SET** button and **UP** arrow and hold for 3 seconds.
2. Push **SET** button to advance through settings until you get to the screen Loc.
3. Push **UP** to increase number or **DOWN** arrow to decrease number until you get to the number 1, then push **SET** button again until you get to the main screen or allow the screen to timeout to return to the main screen.

RELOCK GENERAL SETTINGS PID MENU 2

1. Push **SET** button and **UP** arrow and hold for 3 seconds.
2. Push **SET** button to advance through settings until you get to the screen Loc.
3. Push **UP** to increase number or **DOWN** arrow to decrease number until you get to the number 0, then push **SET** button again until you get to the main screen or allow the screen to timeout to return to the main screen.

Now the parameters are locked which will prevent any accidental changes.

SETTING MAXIMUM PLATEN TEMPERATURE

If you prefer to set a maximum platen temperature, you'll need to unlock the General Settings PID Menu 1 and 2 before following the steps below.

1. Push **SET** button and **UP** arrow and hold for 3 seconds.
2. Push **SET** button to advance through settings until you get to the screen d1H.
3. Push **UP** to increase number or **DOWN** arrow to decrease number until you get to the maximum temperature, then push **SET** button again until you get to the main screen or allow the screen to timeout to return to the main screen.

WARRANTY

Thank you for your purchase of the TRP Stack Rosin Press.

The Trinator TRP Stack Rosin Press is covered by our manufacturer's warranty as follows:

- Warranty coverage for one (1) year or 1,000 operating hours, whichever occurs first, on motors, electrical components, and the remainder of machine components.

The warranty period begins on the date the equipment is received by the customer. Any damage that occurs during shipping will be the responsibility of Trinator.

The above terms are valid if Trinator equipment is used and maintained as directed. If the equipment is modified in any way, all terms of this warranty are void. This warranty does not apply to cosmetic damage, such as scratches or general wear and tear.

Should you experience a technical problem with your equipment, please contact Eteros Technologies at the email or phone number outlined in the [Service and Repairs](#) section.